



DIAMOND HUNTER SMART

User Manual

Manuel de l'Utilisateur



USER MANUAL

ENGLISH





Contents

1	Critical Warning.....	6
2	Features and Specifications.....	7
3	Assembly.....	10
4	Components Overview	12



13 User Interface

5

15 Device Operations Steps

6

22 Parts and Accessories

7

23 Technical Specifications

8



Critical Warning

- Please be sure that all precautions are taken against risks.
- Do not use your device while it is raining or when the wind is too strong.
- Turn on the device after you make sure that all parts are in place and connected.
- Make sure that the device battery is fully charged before you start searching.
- If the indicator on the device starts flashing, turn off the device and recharge the battery.
- When the battery will almost die the device will turn off automatically.
- If the device is not used correctly, or there is a high rate of noise, the device will not be capable of confirming the target and determining the depth.
- It is recommended to read the user manual before starting the device to understand everything and to avoid mistakes during the search.
- Be aware of (energy sources - phone networks - metals - mobile phones - electronic devices), and do not use any charger other than the original device charger.
- The device main unit is under two (2) years warranty against all electronic breakdowns, any damages caused by user errors (falls, opening the main unit, hits, harms, etc.) are not covered within this warranty.
- Battery and charger are not under the warranty.
- You should strictly follow the instructions in this user manual to minimize faults and use your device correctly.



Features And Specifications

- Diamond Hunter Smart is a long-range device with three different search systems, supported by 2D imaging technology.



- Diamond Hunter Smart device has multiple features to search for Diamond and gemstones underground.
- It has the system of searching for diamonds and 18 different kinds of gemstones: such as Sapphire, Emerald, Quartz, Topaz, Garnet, Amethyst, Lapis Lazuli, Tourmaline, Columbite, Tanzanite, Turquoise, Peridot, Alexandrite, Cat Eye, Ruby, Jasper, Opal, Aquamarine.



- Super speed in capturing targets and locating them accurately.
- The device works in seven languages: English - Arabic - German - French - Spanish - Italian - Persian.





- The search depth of the Gold Hunter Smart device reaches 50 meters underground and the front-range is 3000 meters square.

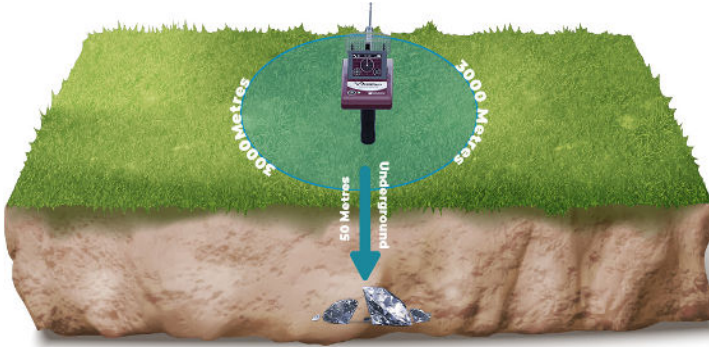

- This device is designed to be compatible in all countries and regions.
- System to select the continent, This unique feature was added due to the different frequencies of underground Diamonds and Gemstones from one continent to another.
- Coloured touch screen.
- Electronic thermometer that measures the weather temperature.
- Digital clock
- Ability to control the device's sound.
- Super speed in capturing targets and locating them accurately.
- The system for determining the target depth easily and accurately.



- Super Antenna which enables the device to cover large areas of research .
- A radar search dish to receive and improve the signal.
- This device is designed to be compatible with its functioning in all countries and regions.
- The Gold Hunter Smart device is one of the best German manufacturers. 
- It holds the European CE certificate, in addition to the international ISO 9001 certificate according to international specifications and standards.



Assembly

1 Install the Receiver Dish



2 Install the Transmitter Antennas

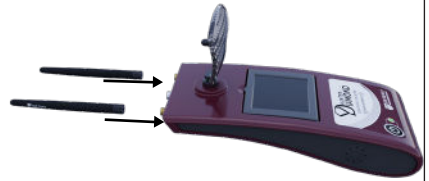

3 Install the Super Antenna VHS



4 Install Receiver Antenna



5 Increase the length of the Receiver Antenna



6 Install the Device Handle



7 Open the Screen





Components Overview

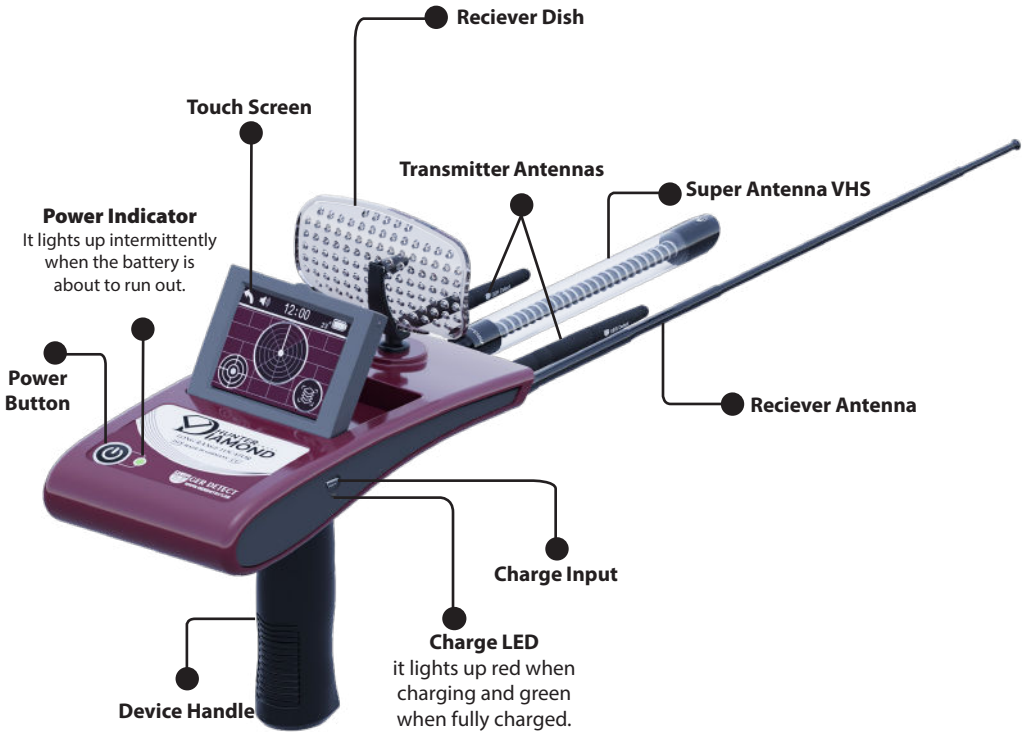

User Interface

After turning on the device, the following data will appear on the main screen

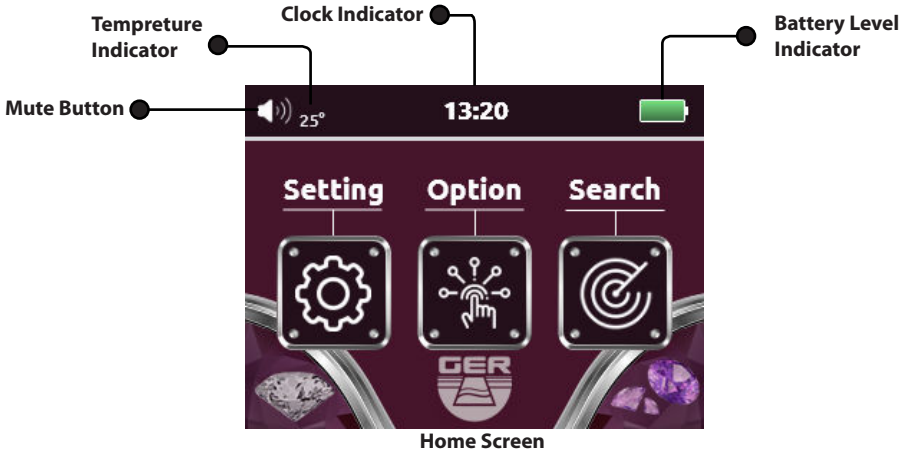

Settings Screen

Includes the languages button, configuration button and Location button.



Languages Screen

It contains the device's languages, which are: German - English - French - Spanish - Italian - Arabic - Persian.





Config Screen:

Device settings: Includes volume and brightness control option.

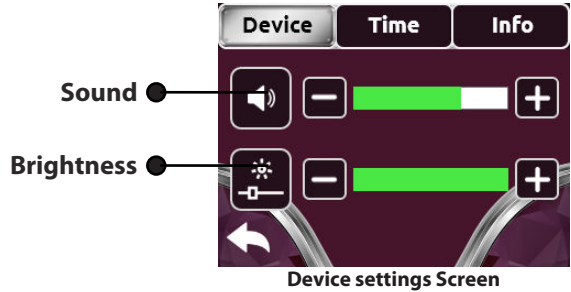

Device settings Screen

Time setting screen



Time setting Screen

Info screen: that includes the device's serial number.

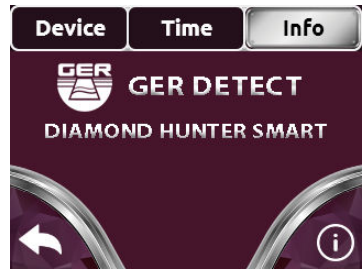

Info Screen

Location Screen:

Includes the continents screen, Where you can Locate and choose the continent you want to search in.

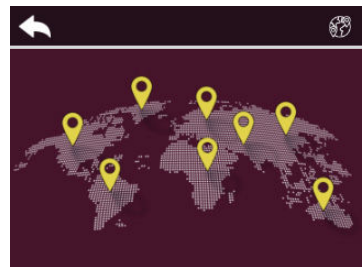

Location Screen



Device Operations Steps

Turn on the device by pressing the power button for two seconds



1. Press Option button

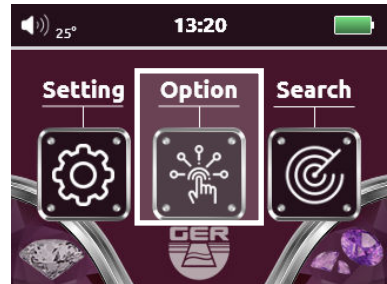

2. Choose the type of target you want to search for underground, you can choose the target you want (example: Sapphire), then set the front range of the device.

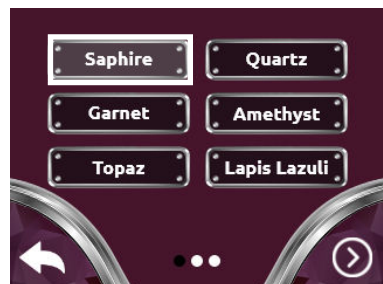
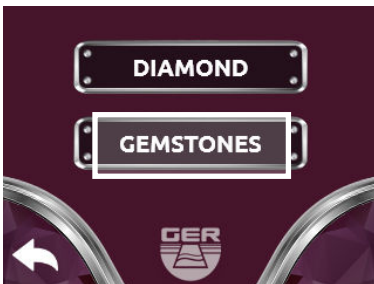



3. choose the front range you want to reach (from 100 meters to 500 meters - 1000 meters - 1500 meters - 2000 meters - 2500 meters - 3000 meters) (for example, 3000 meters)

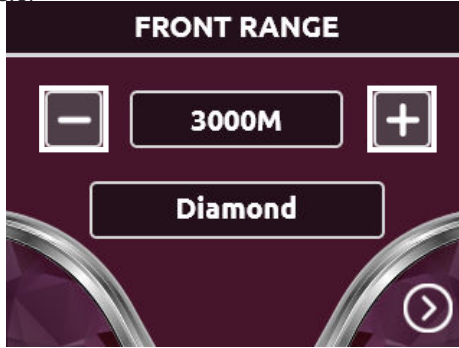

Example: If the front range of the target to be searched for is expected to be within an area of 500 square meters, it is sufficient to specify the front range within 500 meters.

But if the front range of the target to be searched is unknown, you can specify the front range up to 3000 meters.

Note: While searching, the explorer must walk from north to south. the ionic fields are radiations emitted by diamonds and gemstones after being underground for a long time. They overlap and interact with the soil, the nature of the earth's formation, and its regularity with magnetic lines that align to the north and south.

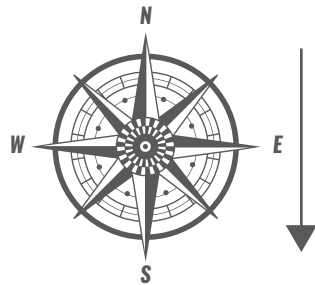



4. When you press the search icon, the device will start searching directly.

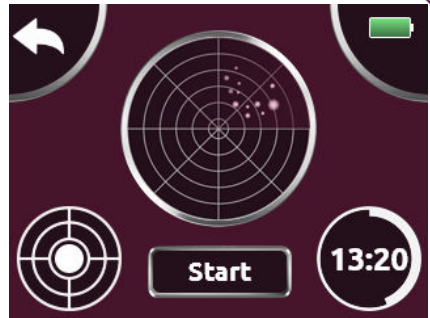

You can also go to the search screen by pressing the search button from the home screen

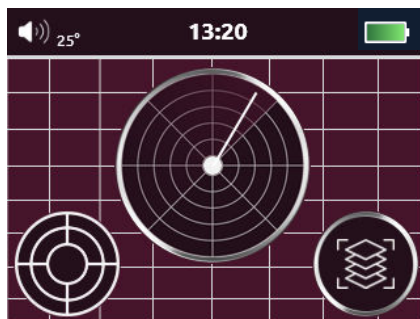
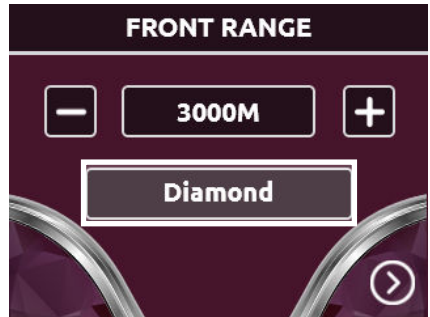
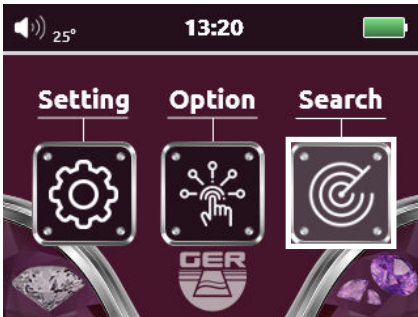



The balance of the device must be maintained during the search by fixing the **Grey dot** in the middle of the circle icon.

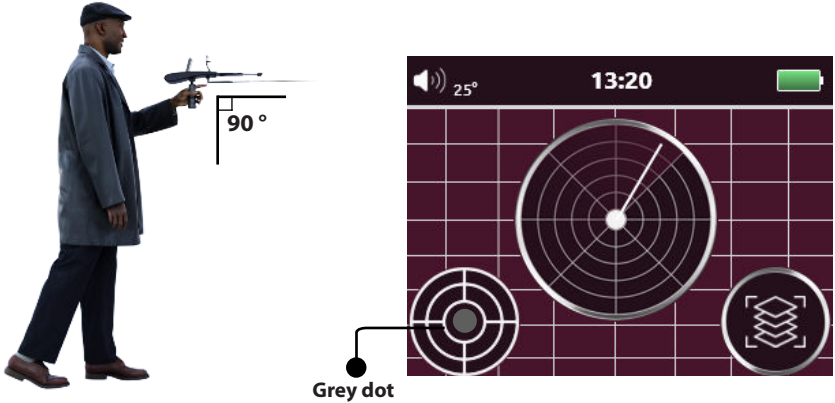

The device will start sending and receiving signals directing you towards the target with a continuous sound.

When getting any signal, the device will directly turn towards the target with the target direction indicator appearing on the screen and the sound accelerating. Confirm the direction of the target from four directions to ensure that the target is reached precisely.

Follow the signal and when the device turns back you will have passed the target.

Limit the search site by placing a mark that will be the center for target confirmation.

Then confirm the location of the target from the four directions (from south to north - from north to south - from west to east - from east to west).

When standing above the center of the target, the device will rotate directly above the target.

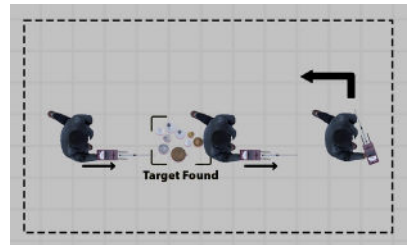



After you have confirmed the location of the target, click on the **Depth button** to determine the depth and then move away from the center of the target a distance of at least two meters.

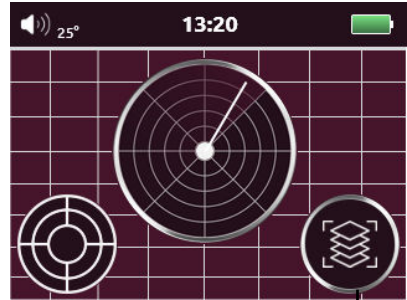

Depth Button ●





Point the device towards the target while maintaining the balance of the device, press the **start button**, wait until you hear a beep from the device, then walk towards the target until the device rotates backwards with the appearance of an icon indicating the rotation of the device towards the back.

Start Button

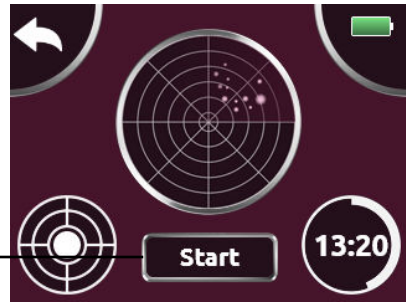

Turn in the opposite direction, press the start button, wait until you hear a beep emanating from the device, and the icon shifts from the rotation position to the forward position, then walk until the device rotates backwards, the device will analyze and show the final results automatically.

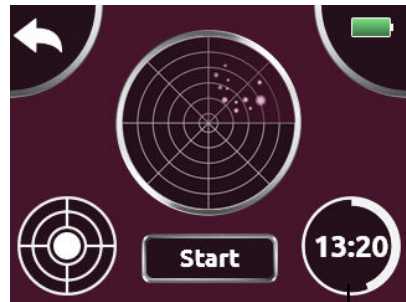

Direction Arrow

The following results will appear on the device screen when confirming the presence of a target:

Noise: It is the percentage of noise in the search area, which results from the proximity of (energy sources - phone networks - metals - mobile phones - electronic devices)

Target confirmation: the percentage of confirmation of the presence of the target in the search area.

Depth: The depth within which the target is likely to be located.

Example: the depth is between 23 cm to 42 cm, Noise 5%, Target confirmation 93%

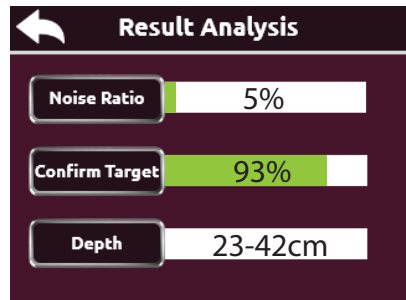



Important Note:

- If the result analyzer shows the noise **more than 30%** It is recommended to repeat the search to get a more accurate depth result.
- If the target confirmation rate is **less than 90%** it is recommended to repeat the search.
- The target must be buried for many years so that by the time and the interaction with the soil's composition, an ionic field will be formed which will enable the device to detect the target.

Therefore, testing the device on diamonds or gemstones laid on the ground or newly buried under the ground will not show the real capacity and functionality of this device to detect the target or to reach larger depths.

The reason for that is that the ionic fields are radiations from Diamonds and other Gemstones that have been in the ground for a long time and have intersected and interacted with the soil and the nature of the earth as well as having been regulated with magnetic fields north and south – These features do not apply for freshly buried or surface laid diamond or gemstones.

How to find the precise center of the target:

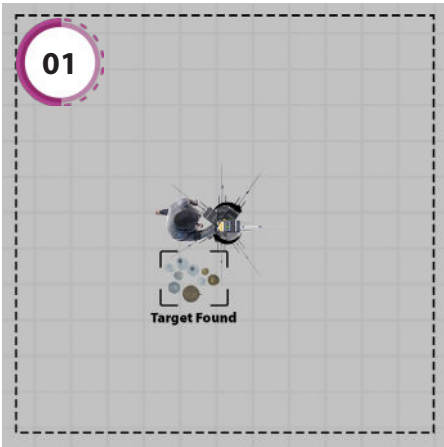

1. After reaching the target, the device will turn 360° continuously.

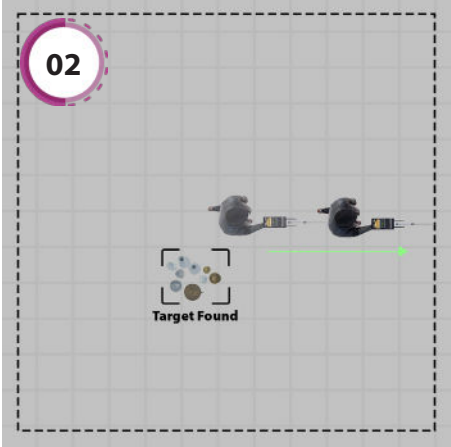

2. Move about two meters away from the target

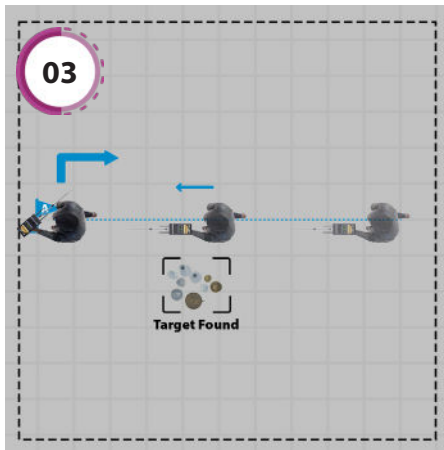

3. Turn and Walk towards the target until the device turns, put a mark representing the first point (Flag A).

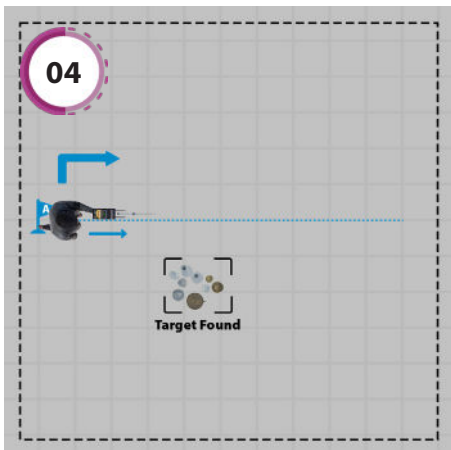

4. After putting the mark turn around to walk in the opposite direction.

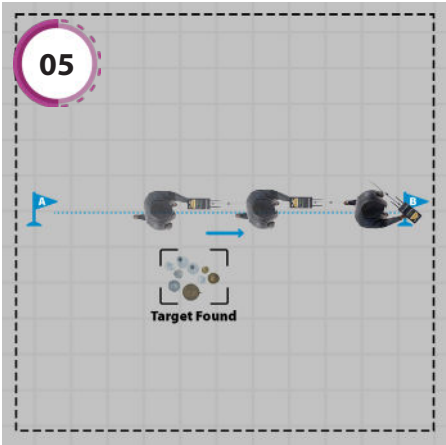

5. Keep walking in a straight line until the device turns. put the second mark on the second point (Flag B)

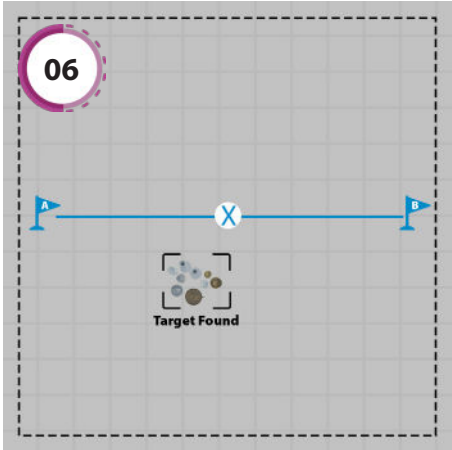

6. Measure the distance between the two points, put another mark (Blue X) in the middle of the line.



7. Starting from the middle point (Blue X), walk away about two metres in a straight line, then turn around.

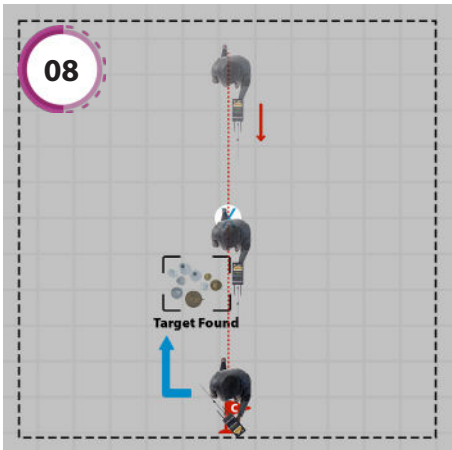

8. start walking towards the target and keep walking until the device turns, put a mark (Flag C).

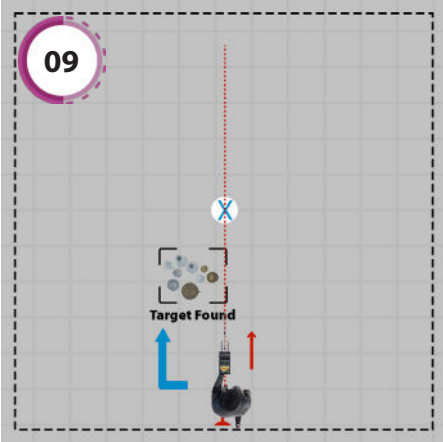

9. After putting the mark turn around to walk in the opposite direction.

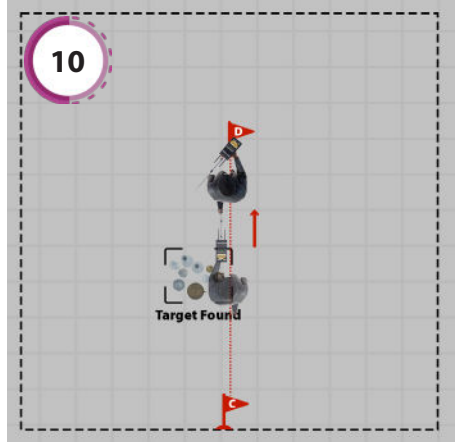

10. Walk in the opposite direction in a straight line towards your target and keep walking until the device turns again, put a mark (Flag D)

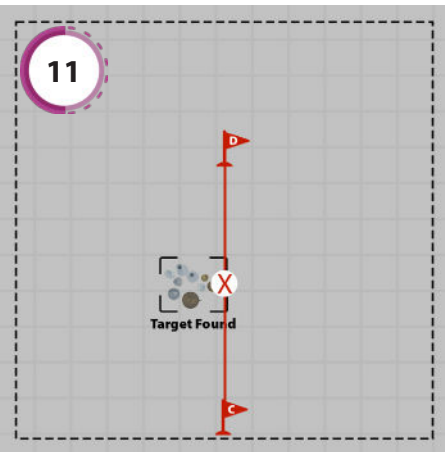

11. Measure the distance between the the points C and D, and put a mark (Red X) in the middle, the target is found in this point.



Parts and Accessories

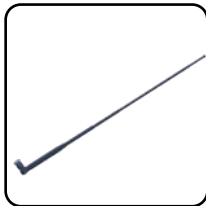

**Receiver
Antenna**



**Signal Receiver
Dish**



**Super Antenna
VHS**



**Transmitter
Antennas**



Handle



Carrying Bag



Car Charger



Charger



Warranty Card



Technical Specifications

AUDIO OUTPUT	Dynamic speaker frequency 350~5500 Hz sound output: 84 ± 3dB
Liquid Crystal Display (LCD)	touch screen full color 320 x 240 px
Length	Device: 220 mm
	The device with antenna of 425 mm (not extended)
	Device with antenna 695 mm (extended)
Frequency	3.2 _ 16 KHz
Data processing speed	180 MHz
Operating Temperature Range	0 C° to 70 C°
Operating Humidity Range	Up to 95 % non-condensing
Storage Temperature Range	- 20C° to 70C°
Storage Humidity Range	Up to 98 % Relative Humidity
Operating Time (18 Wh Battery)	10 Hours
Waterproof Rating	Not waterproof

Li-ion Battery

Type	Li-ion Rechargeable Battery - internal Battery
Output Voltage	Li-ion 3.6 VDC
Capacity	Li-ion 18 Wh
Run Time	10 Hours
Battery Operating Temperature	0 C° to 50 C°
Battery Storage Temperature	- 5C° to 70C°

Li-ion Battery Charger

Operating Temperature	0 C° to 50 C°
Storage Temperature	- 30 C° to 80 C°
Input Voltage	90-250 VAC 50-60 Hz
USB Output Current	5 VDC / 2100 mA

Other

Total weight	2720 g
Device weight	325 g
Bag weight (empty)	2160 g
Bag dimensions	42.5 cm x 17.5 cm x 28 cm



**Thank you for choosing
DIAMOND HUNTER SMART**



UIG DETECTORS

Diamond & Gemstones Detectors



+90 539 544 02 23

+90 531 852 40 31



info@uigdetectors.com



www.uigdetectors.com